

## SYSTEM DESIGN

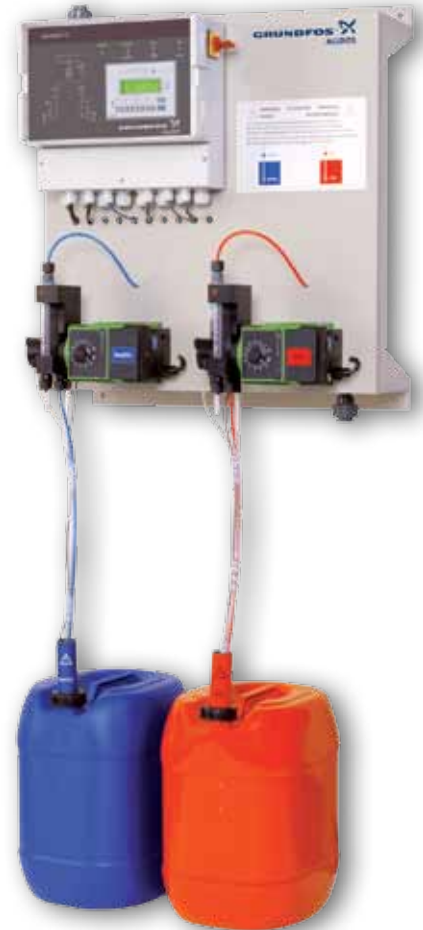
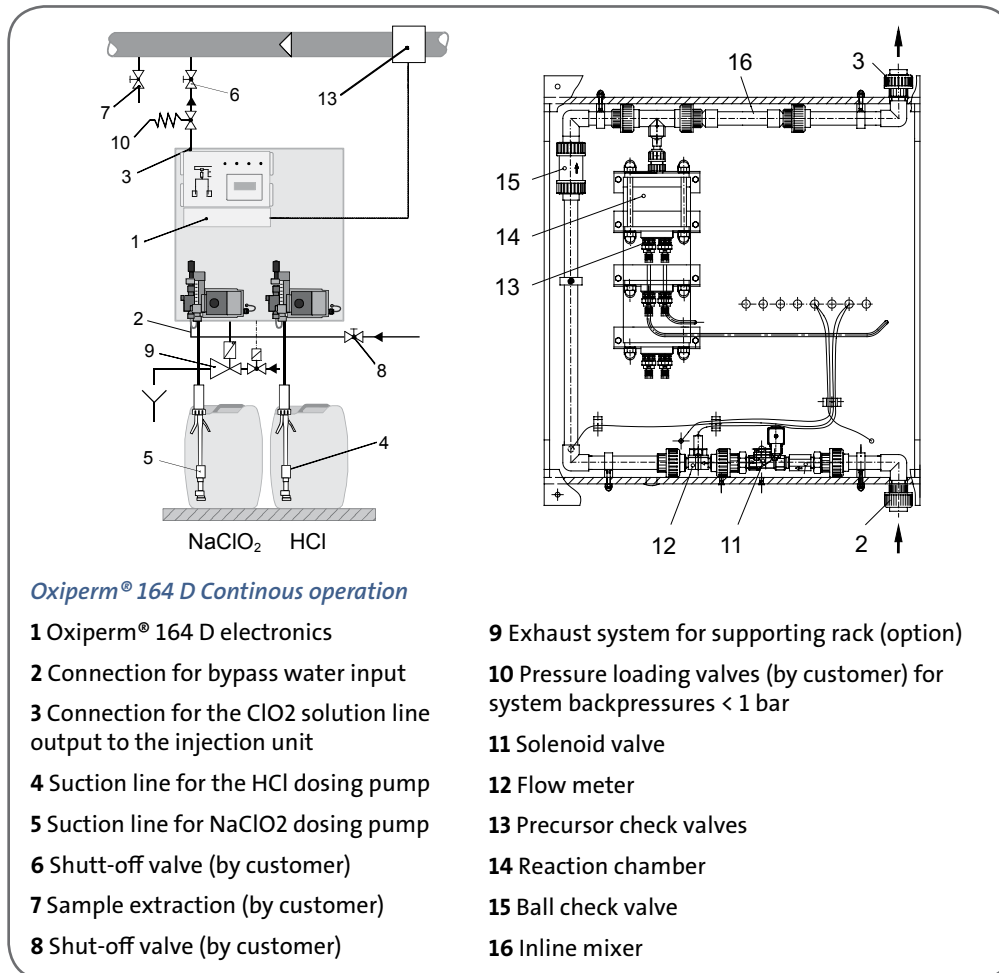

## PERFORMANCE AND CONSUMPTION DATA

ClO <sub>2</sub> preparation capacity [g/h]	p <sub>max</sub> [bar]		Consumption of components [l/h]		Consumption of bypass water [l/h] (input pressure < p <sub>max</sub> )			Weight [kg]	Type
	50 Hz	60 Hz	HCl	NaClO <sub>2</sub>	continuous operation	batch operation *)			
						0.5 - 2 g/l	2 - 3.3 g/l		
30	10	10	0.7		420	14	14 - 7.7	33	164-030D (DFI)
120	9	6	2.9		420	55	55 - 31	34	164-120D (DFI)
220	7	7	5.2		420	100	100 - 56	34	164-220D (DFI)
350	9	9	8.3		420	160	160 - 89	57	164-350D
700	9	9	16.5		900	320	320 - 179	62	164-700D
1000	9	9	24		900	450	450 - 258	66	164-1000D
1500	9	9	35		900	680	680 - 383	76	164-1500D
2000	9	6	48		900	900	900 - 517	82	164-2000D

\* This quick guide does not replace the IOM.  
Please refer to the IOM product detailed technical instructions

## SERVICE OPERATION

### STARTUP MODE

#### Batch Concentration

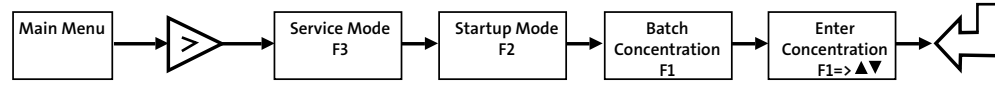

#### Bypass Water

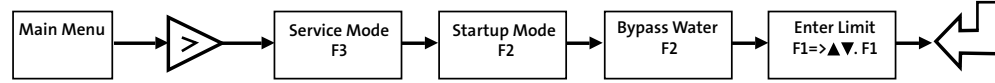

#### Start

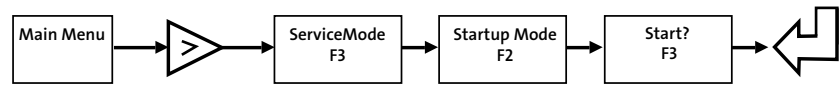

### VENTING

#### Venting the Bypass line

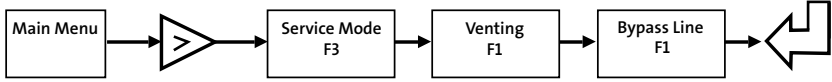

#### Venting the HClO2

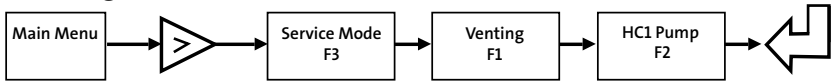

#### Venting the NaClO2

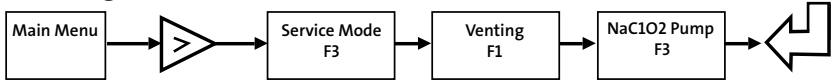

#### Venting the H2O Pump

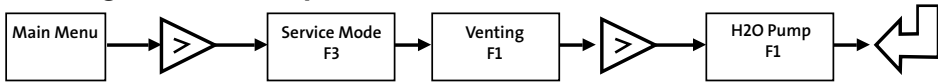

### SYSTEM CHOICE

To return to the main menu press Esc three times.

#### System Choice / System Selection

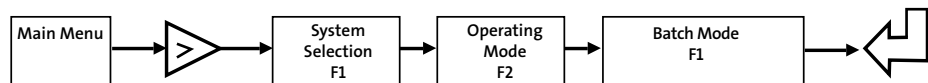
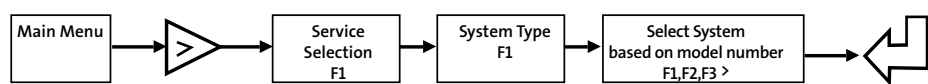

### SETUP

#### Code Function (optional)

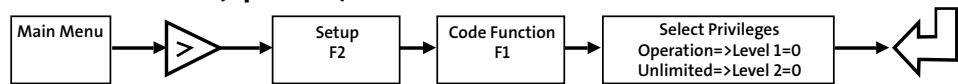

### STARTING UP

#### Automatic Mode

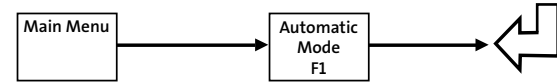

#### Manual Mode

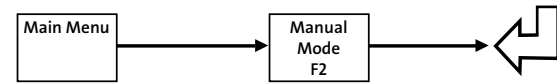

### VIEWING ALARMS

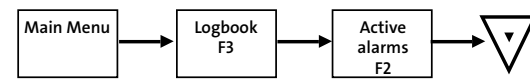

### CLEARINGS ALARMS

#### Single Alarm

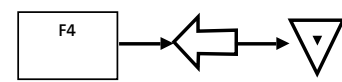

#### Multiple Alarm

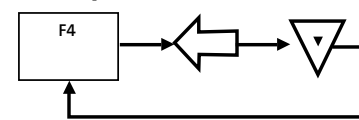

### SYSTEM INFORMATION

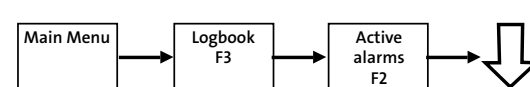

### CHECKING STATUS / DISPLAYING INFORMATION

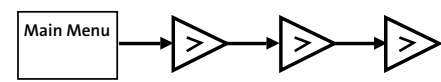

## CONTROL AND DISPLAY ELEMENTS

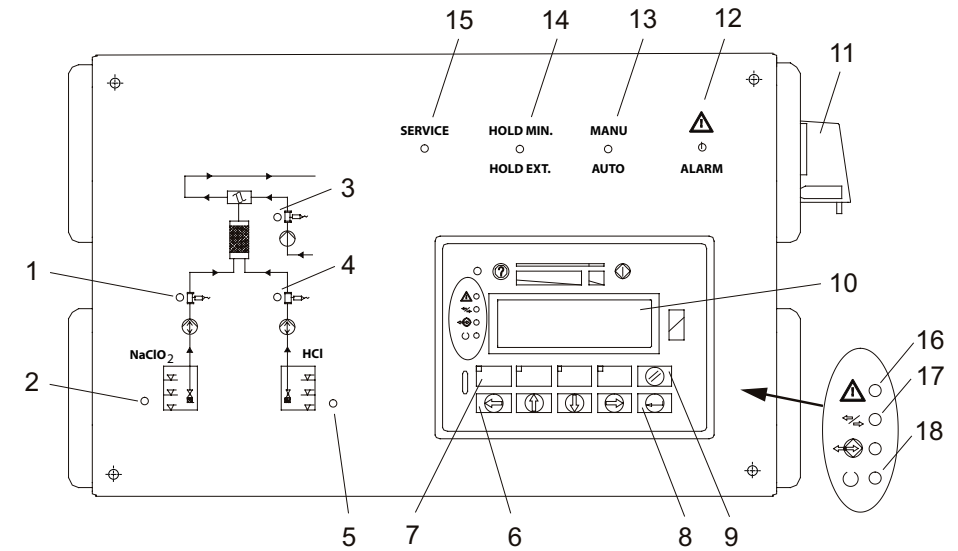

### LEGEND

- Item1 ..... LED - dosing controller for NaClO2 flow  
LED flashes with correctly set dosing controller
- Item2 ..... LED for NaClO2 tank  
LED off, level OK  
LED flashes with advanced empty alarm  
LED on, empty alarm
- Item3 ..... LED for bypass water  
LED on, bypass water OK  
LED flashes if bypass water outside tolerance
- Item4 ..... LED - dosing controller for HCl flow  
LED flashes with correctly set dosing controller
- Item5 ..... LED for HCl tank  
LED off, level OK  
LED flashes, advanced empty alarm  
LED on, empty alarm
- Item6 ..... Arrow keys for moving in the display menus
- Item7 ..... Function keys F1, F2 and F3  
Selection possibility for individual menu items  
Function key F4 - reset
- Item8 ..... "Enter" key, confirm inputs
- Item9 ..... Escape key to cancel/switch over to submenu
- Item10 ..... Display, 4-line
- Item11 ..... Master switch with EMERGENCY STOP function
- Item12 ..... LED for alarms  
LED on or flashing with alarm present
- Item13 ..... Display of automatic or manual mode  
LED flashes: manual control  
LED on: automatic control
- Item14 ..... LED for remote on/off mode  
LED flashes: remote on/off by MIN contact for main water  
LED on: remote on/off by external contact
- Item15 ..... LED for servicing  
LED flashes: system in service menu
- Item16 ..... LED for alarms on the display  
LED on or flashing with alarm present
- Item17 ..... Connection of display to PLC  
LED on, connection OK
- Item18 ..... LED for display  
LED on, display in operation

### DISPLAY MENU

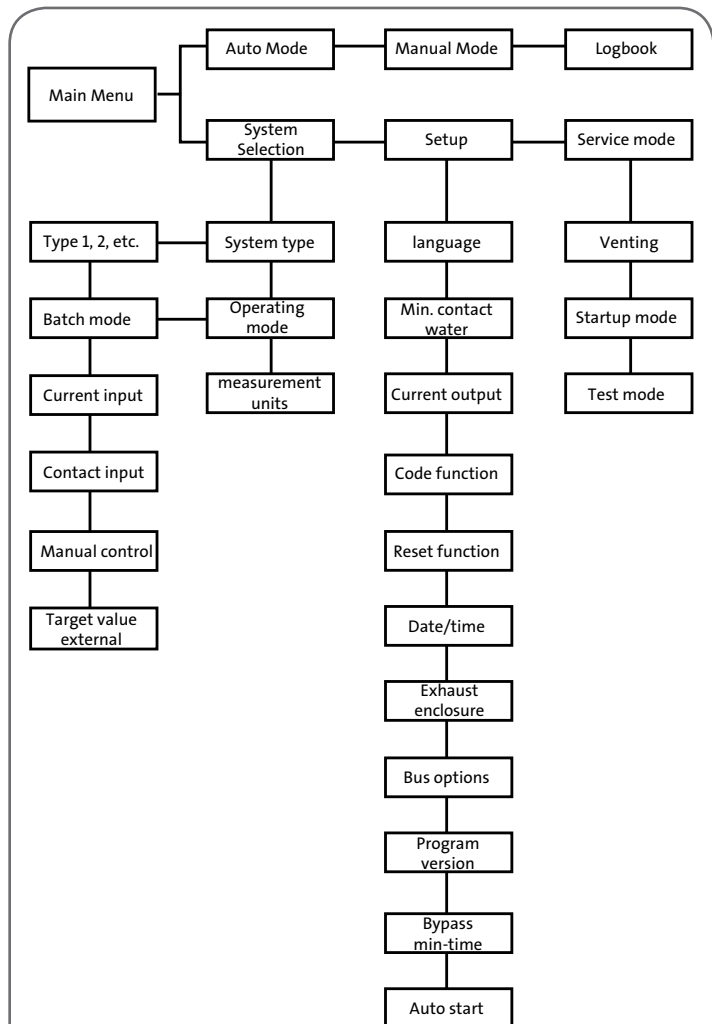

# WIRING DIAGRAM

Power Supply			
L	N	PE	
1	2	3	Power supply - input
4	5	6	Power supply - output
7	8	9	
10	11	12	HCl dosing pump
13	14	15	NaClO <sub>2</sub> dosing pump
16	17	18	
19	20	21	
22	23	24	Solenoid valve: bypass/pump
25	26	27	
28	29	30	
Floating Outputs			
Common point	NC contact	NO contact	
31	35	33	Fault
32	36	34	Adv. empty alarm HCl/NaClO <sub>2</sub>
37	41	39	Automatic
38	42	40	Tank run dry
Inputs			
+8V	GND	IN	
59 brown	60	61 blue	Dosing controller NaClO <sub>2</sub>
63 brown	64	62 blue	Dosing controller HCl
65	66	67	
69 brown	70 white	68 green	Bypass water impeller meter
+12V	GND	IN	
43		44	Batch tank...ClO <sub>2</sub> overflow
45		46	Batch tank...ClO <sub>2</sub> max.
47		48	Batch tank...ClO <sub>2</sub> min.
49		50	Batch tank...ClO <sub>2</sub> run dry
51 brown		52 white	Advanced empty alarm NaClO <sub>2</sub>
		53 green	Empty alarm NaClO <sub>2</sub>
		54 green	Empty alarm HCl
55 brown		56 white	Adv. empty alarm HCl
57		58	
71 white	72 brown	73 green	Hall-effect sensor, NaClO <sub>2</sub> pump
75 white	76 brown	74 green	Hall-effect sensor, HCl pump
77 white	78 brown	79 green	
	81	80	
83		84	Contact input, water meter
85		86	Remote on/off
87		88	Fault in gas warning equipment
89		90	Contact, main water min.
91		92	
Analog Signal			
Shield	IN/OUT -	IN/OUT +	
95	94 IN -	93 IN +	Analog IN
96	98 OUT -	97 OUT +	Analog OUT

